



CXP-8A-N2930IPF

Features

- 8" Industrial Compact Size Panel PC
- Flat front panel touch screen
- Fanless design
- Intel Celeron Processor N2930(1.83GHz) CPU built-in
- Onboard DDR3L 4GB /1600MHz
- 9~36V DC Wide-ranging Power Input
- IP65 compliant front panel



Technical Specifications

LCD

8" LED 800 x 600

Brightness (cd/m2)

350

Contrast Ratio

500:1

CPU

Intel Celeron N2930

Memory

Onboard 1600 MHz dual-channel DDR3L
supports up to 4GB

OS Support

Windows

Touch Panel

Projected Capacitive Touch

I/O

2 x USB 3.0 , 1 x COM (RS232/422/485), 1 x COM (RS232)
2 x LAN

Dimention (WxHxD)(mm)

202 x 149 x 40

Power

DC 12V

Operating Temperature

0°~50°C

Storage Temperature

-20°~60°C

COMX

17F-10 NO. 79, SEC 1 XINTAI 5th RD.,
XIZHI DIST, 221, NEW TAIPEI CITY
22101 TAIWAN

Tel: +886 2 8698 3608
Fax: +886 2 8698 3606



Technical Drawing

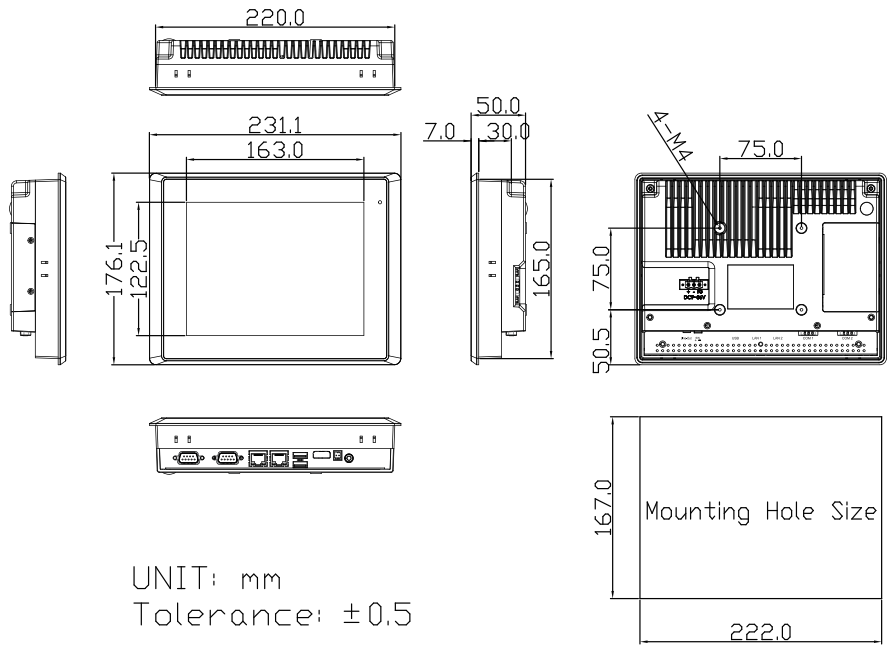

Packing & Options

I/O & Control keys

Packaging

- System
- Power adaptor
- AC power cord
- Drivers & manual

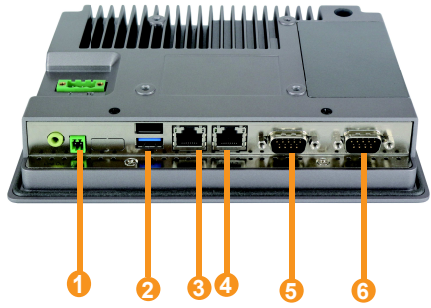

- 1 DC 12 V
- 2 USB
- 3 LAN
- 4 LAN
- 5 COM
- 6 COM



Front



Back